

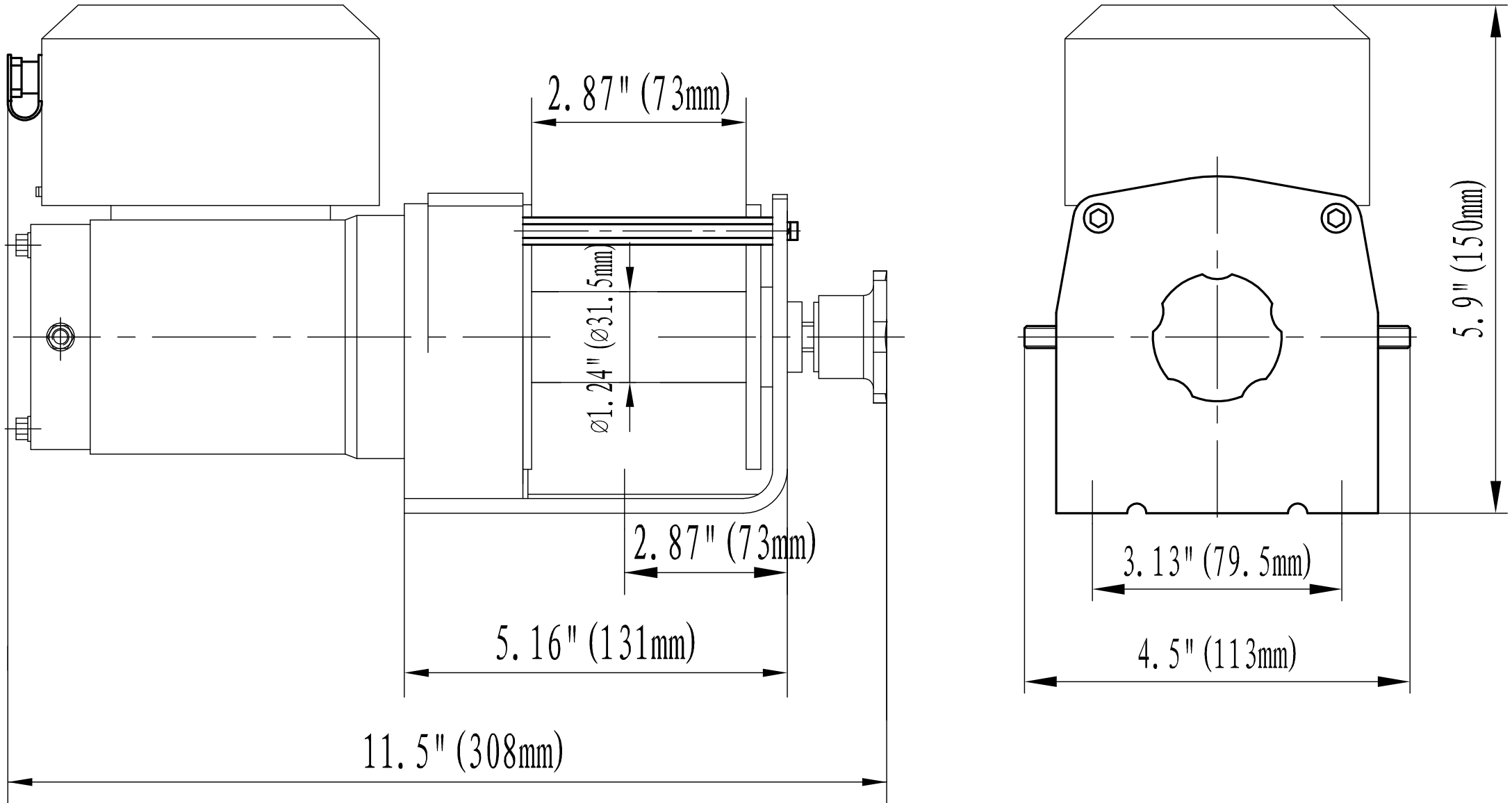

C2 000 A TECHNICAL DIAGRAM



VALUE WITHOUT COMPROMISE